

If you have any questions or comments relating to Samsung products, please contact the SAMSUNG customer care center.

COUNTRY / LOCATION	Customer Care Center	Web Site
AUSTRALIA	1300 362 603 (Other) 1300 425 299 (HHP)	www.samsung.com/au/support
HONG KONG	3698 4698	www.samsung.com/hk/support (Chinese) www.samsung.com/hk_en/support (English)
MALAYSIA	1800-22-8899 (HHP) 1800-88-9999 (OTH) +603-7713 7420 (Overseas contact)	www.samsung.com/my/support
SINGAPORE	1800 7267864 1800-SAMSUNG (Other) 1800 4252997 1800-GALAXYS (HHP)	www.samsung.com/sg/support
SOUTH AFRICA	0860 SAMSUNG (726 7864)	www.samsung.com/za/support
INDIA	1800 40 SAMSUNG (1800 40 7267864) (Toll-Free) 1800 5 SAMSUNG (1800 5 726864) (Toll-Free)	www.samsung.com/in/support

VR05R50** Series**
INSTRUCTION MANUAL

English

This product is RoHS compliant



Please keep this instruction manual carefully, and read it before operating

SAFETY INSTRUCTIONS



When using an electrical appliance, basic precautions should always be followed, including the following:

READ ALL THE INSTRUCTIONS BEFORE USING (THIS APPLIANCE), Failure to follow the warnings and instructions may result in electric shock, fire and/ or serious injury.

WARNING- To reduce the risk of fire, electric shock, or injury:

1. Do not use outdoors or on wet surfaces.
2. Do not allow to be used as a toy. Close attention is necessary when used by or near children, pets or plants.
3. Use only as described in this manual. Use only manufacturer's recommended attachments.
4. Do not use with damaged cord or plug. If appliance or docking station is not working as it should, has been dropped, damaged, left outdoors, or dropped into water, return it to a service center.
5. Do not pull or carry by cord, use cord as a handle, close a door on cord, or pull cord around sharp edges or corners. Do not run appliance over cord. Keep cord away from heated surfaces.
6. Do not unplug by pulling on cord. To unplug, grasp the plug, not the cord.
7. Do not handle charger, including charger plug, and charger terminals with wet hands.
8. Do not put any objects into openings. Do not use with any opening blocked; keep free of dust, lint, hair, and anything that may reduce air flow.
9. Keep hair, loose clothing, fingers, and all parts of body away from openings and moving parts.
10. Do not use to pick up flammable or combustible liquids, such as gasoline, or use in areas where they may be present.
11. Do not pick up anything that is burning or smoking, such as cigarettes, matches, or hot ashes.
12. Do not use without dust bin and /or filters in place.
13. Prevent unintentional starting. Ensure the switch is the o_-position before connecting to battery pack, picking up or carrying the appliance. Carrying the appliance with your finger on the switch or energizing appliance that have the switch on invites accidents.
14. Disconnect the battery pack from the appliance before making any adjustments, changing accessories, or storing appliance. Such preventive safety measures reduce the risk of starting the appliance accidentally.
15. Recharge only with the charger specified by the manufacturer. A charger that is suitable for one type of battery pack may create a risk of fire when used with another battery pack.
16. Use appliance only with specifically designated battery packs. Use of any other battery packs may create a risk of injury and fire.
17. When battery pack is not in use, keep it away from other metal objects, like paper clips, coins, keys, nails, screws or other metal objects that can make a connection from one terminal to another. Shorting the battery terminals together may cause burns or a fire.
18. Under abusive conditions, liquid may be ejected from the battery; avoid contact. If contact accidentally occurs, flush with water. If liquid contacts eyes, additionally seek medical help. Liquid ejected from the battery may cause irritation or burns.
19. Do not use a battery pack or appliance that is damaged or modified. Damaged or modified battery may exhibit unpredictable behavior resulting in fire, explosion or risk of injury.
20. Do not expose a battery pack or appliance to fire or excessive temperature. Exposure to fire or temperature above 130°C may cause explosion.

CAUTION

21. Do not use and store in extremely hot or cold environments (below 4°C or above 40°C). Please charge the robot in temperature above 4°C and below 40°C.
22. Follow all charging instructions and do not charge the battery pack or appliance outside of the temperature range specified in the instructions. Charging improperly or at temperatures outside of the specified range may damage the battery and increase the risk of fire.
23. Having servicing performed by a qualified repair person using only identical replacement parts. This will ensure that the safety of the product is maintained.
24. Do not modify or attempt to repair the appliance or the battery pack except as indicated in the instructions for use and care.
25. Place the cords from other appliances out of the areas to be cleaned.
26. Do not operate the vacuum in a room where an infant or child is sleeping.
27. Do not operate the vacuum in an area where there are lit candles or fragile objects on the floor to be cleaned.
28. Do not operate the vacuum in a room that has lit candles on furniture that the vacuum may accidentally hit or bump into.
29. Do not allow children to sit on the vacuum.
30. Do not use the vacuum on a wet surface.
31. Do not use the docking station if it is damaged.
32. Turn off the power switch before cleaning or maintaining the appliance.
33. The plug must be removed from the receptacle before cleaning or maintain the docking station.
34. Remove the appliance from the docking station and turn o_ the power switch to the appliance before removing the battery for disposal of the appliance.
35. If the robot will not be used for a long time, fully charge the robot and power OFF for storage and unplug the charger.
36. For use only with VCA-RDS50 docking station.
37. This appliance is not intended for use by persons (including children) with reduced physical, sensory or mental capabilities, or lack of experience and knowledge, unless they have been given supervision or instruction concerning use of the appliance by a person responsible for their safety. Cleaning and user maintenance shall not be made by children without supervision.
38. Do not pour some water or liquid on the appliance. It could be increased the risk product breakaway or fire.
39. Do not use POWERbot near a heater or combustible materials.
– Do not use POWERbot near fire or flame such as a movable heater, a candlelight, a desk lamp, a fireplace etc. or in a place where combustible materials such as gasoline, alcohol, thinner etc. exist.
40. Make sure there are no dangerous objects around the POWERbot's cleaning area to prevent collision and unplug any electric heaters or fans.

Household use only.

Product Introduction

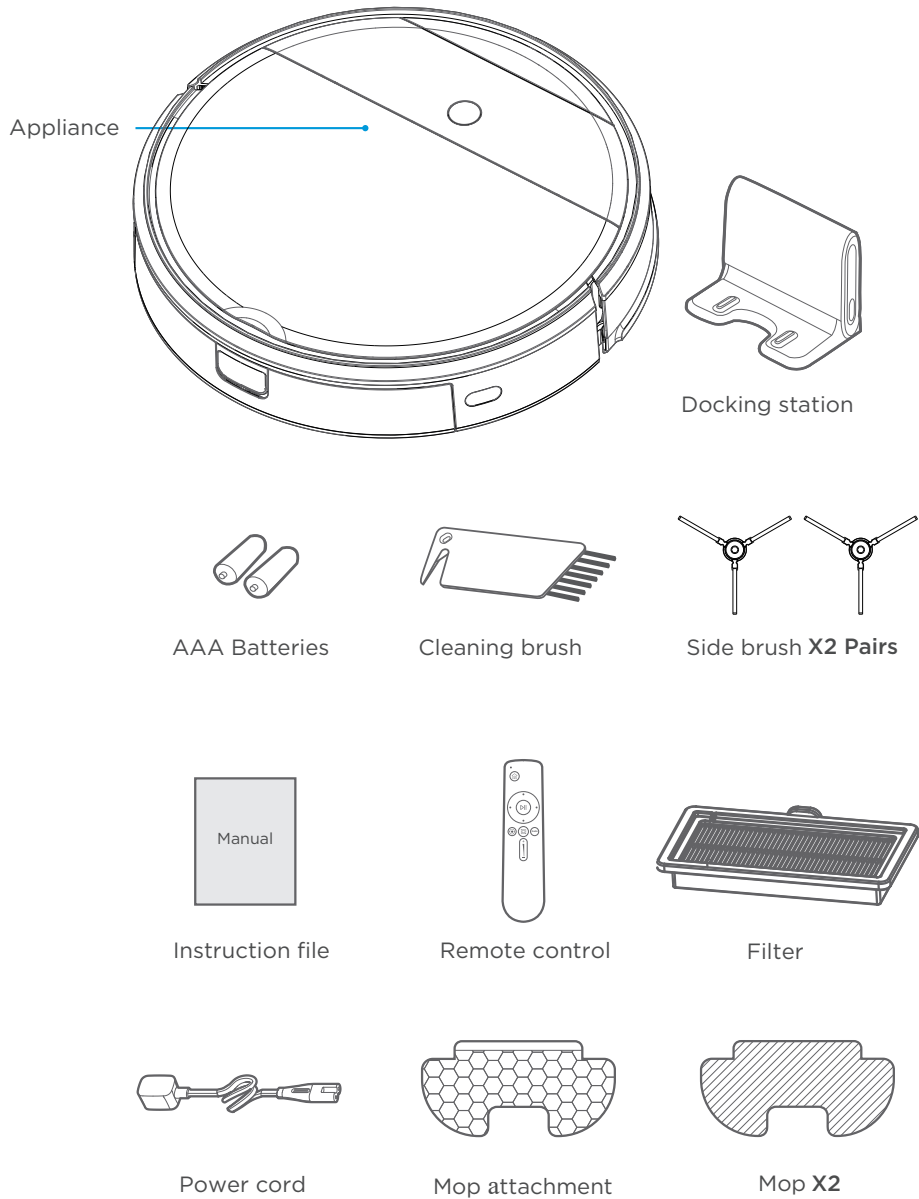

Product Operation

⚠ Caution

1. Do not use your robot on wet surfaces or surfaces with standing water. Before using the product on a rug with tasseled edges, please fold the rug edges under.

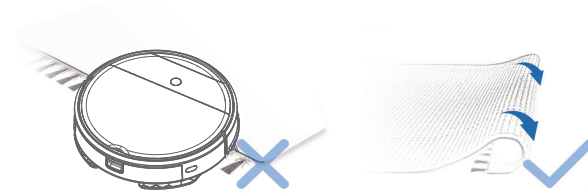

2. It may be necessary to place a physical barrier at the edge of a drop to stop the unit from falling over the edge.

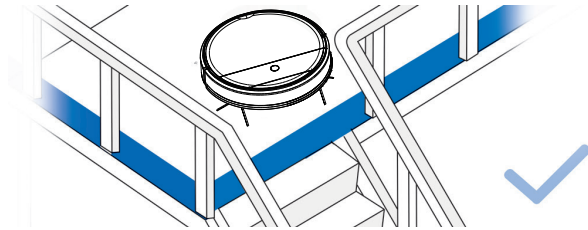

3. Remove power cords and small objects from the floor that the robot could be obstructed by, and tidy up the area to be cleaned by putting furniture, such as chairs, in their proper place.

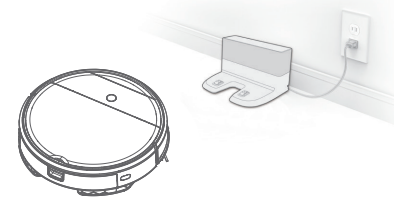

4. Please remove all the stuff on the floor, like slipper, cord, curtain, etc. to make sure the robot works regularly.

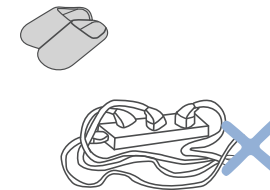

Quick start guide

First use

Step 1

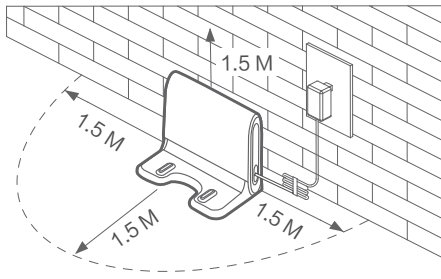

Step 2

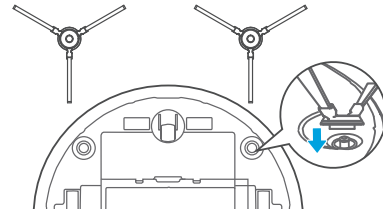

Step 3

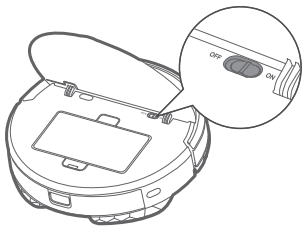

Step 4

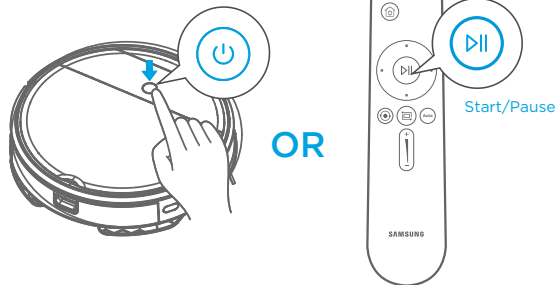

Step 5

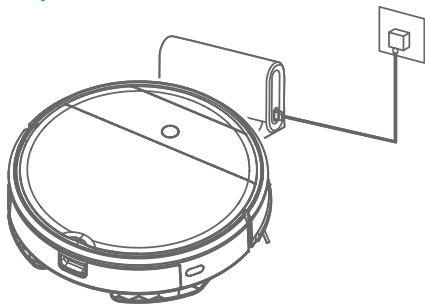

Quick start guide

For mopping system

1 Attach the mop to the mop attachment.

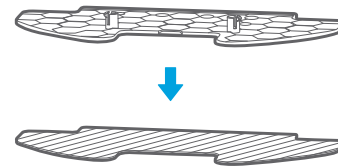

2 Press the button on tank and remove the tank.

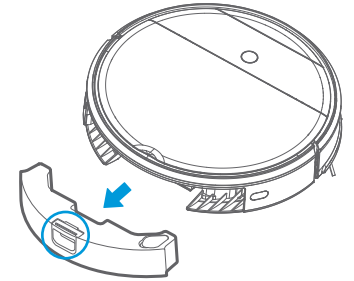

3 Fill the water.

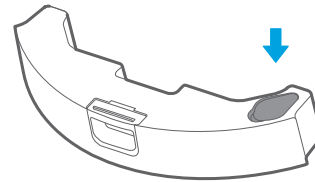

4 Mount the water tank onto the mop attachment.

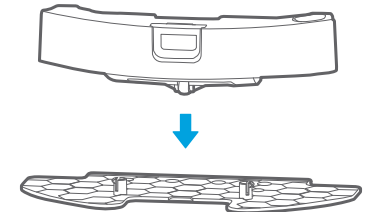

5 Then insert the water tank assembly into the appliance.

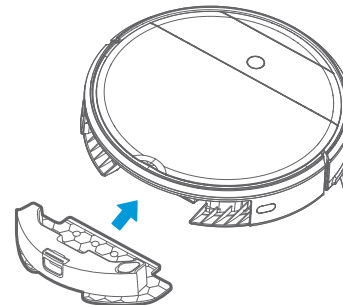

6 Press "⏻" and start mopping.

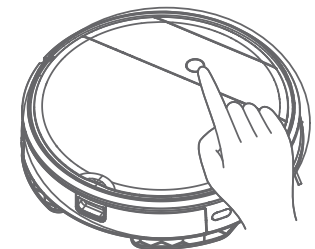

Introduction of Remote Control

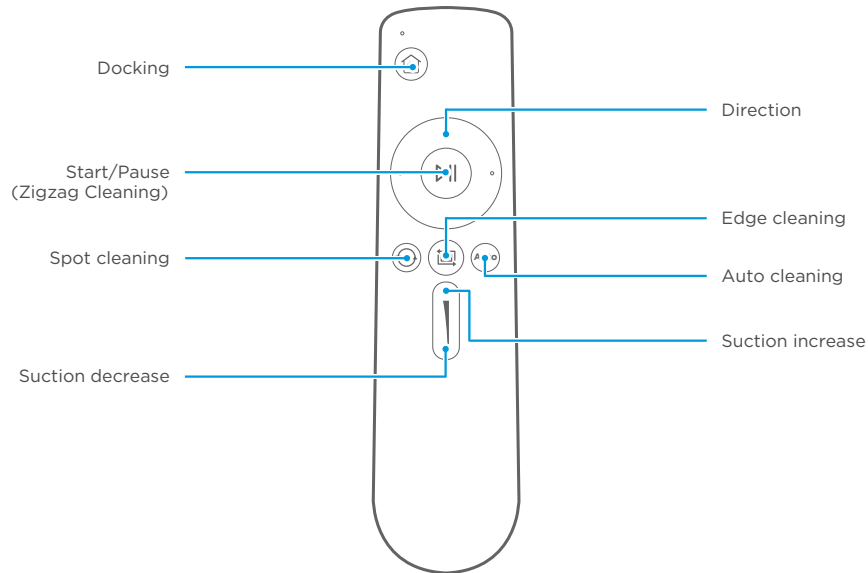

- 1 Docking:** When in standby or working mode, appliance will return docking station for charging.
- 2 Direction:** Controlling the moving direction by forward/left/right key.
- 3 Start/Pause (Zigzag Cleaning):** When in standby mode, appliance start working or pause with zigzag cleaning.
- 4 Spot cleaning:** Start to cleaning by Spiral mode in certain zone.
- 5 Edge cleaning:** Cleaning by the edge of obstacle.
- 6 Auto cleaning:** cleaning in the auto way.
- 7 Suction increase:** Increasing the suction power.
- 8 Suction decrease:** Decreasing the suction power.

⚠ Caution

- Place the battery in remote control before using; Take battery off if not used for a while.
- In case of safety, there's no backward direction function.
- Please operate the remote control within 5m to appliance.

APP Guide Line (POWERbot-E)

App quick guide

Network access guide

Step 1

Search "POWERbot-E" in APPLE App Store or Google Play Store, and download the App. Follow the instructions on the interface to register and login App.

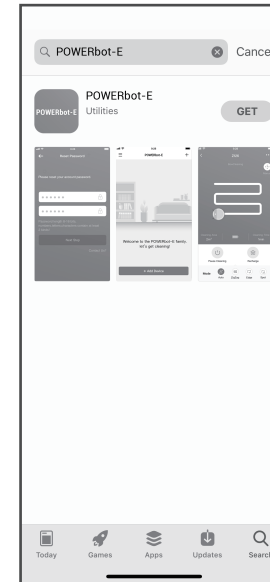

Step 2

Click "+ Add Device" on the interface and operate as instructed.

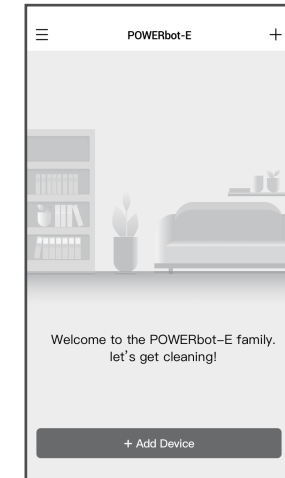

Step 3

When first using, slow flickering of WiFi indicator light indicates that the cleaner gets into the state of network accessing configuration, now click "Next Step" on App and conduct network accessing config operation as per the prompts on the interface.

Remarks: If WiFi indicator light doesn't flicker, long press "⏻" key for 3 seconds and release after a tick sound is heard.



APP Guide Line (POWERbot-E)

App quick guide

Network access guide

Step 4

Once the network access is configured successfully, you can operate your cleaner by App.

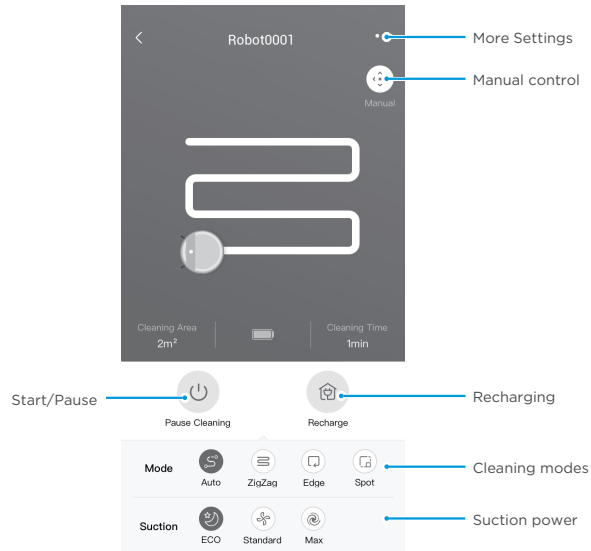

⚠ Caution

Make sure your phone is connected to home WiFi.

APP Guide line(SmartThings)

If you want to use your SmartThings App to control the robot.

STEP 1. Finish the POWERbot-E App registration.

STEP 2. Download the SmartThings App, search "SmartThings" in APPLE App store or Google Play Store and download.

- You must sign in to a Samsung account before using the SmartThings app.

- To set up a Samsung account, you can follow the directions provided by the SmartThings app.

STEP 3. Register in the SmartThings App and login in.

STEP 4. Link the SmartThings App and POWERbot-E App as below instruction, and then can control your robot via SmartThings App.

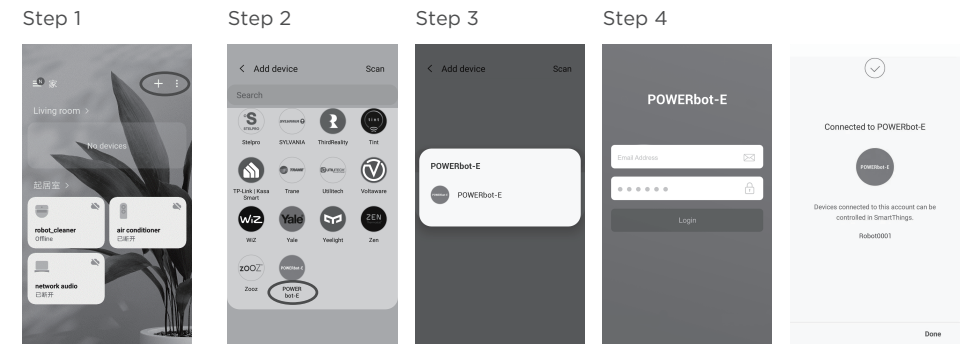

TROUBLE SHOOTING

In case of mis-function, please refer to the following table.

Problem	Possible reason	Solution
The appliance will not be charged	<ul style="list-style-type: none"> - The power switch is not turned on while charging - The appliance and charging terminals are not in full contact 	<ul style="list-style-type: none"> - Power on the appliance - Make sure the appliance is fully in contact with the charging terminal
The appliance gets stuck	<ul style="list-style-type: none"> - The appliance is covered by wires on the ground, dropping curtain fabric or blankets are twined - Side brush and brushroll, etc. get stuck, and the appliance cannot run normally 	<ul style="list-style-type: none"> - The appliance will automatically start the escape mode. If it is not out of trouble, it needs manual help - Clean the windings on the side brush and restart it. If not, contact the after-sales department
Not cleaned completely, and robot goes to recharge	<ul style="list-style-type: none"> - Robot battery is lower than 20%, and it automatically back to recharge - Robot cleans a certain place and is considered as "Cleaning finished" 	<ul style="list-style-type: none"> - Charge the appliance - Restart the appliance and choose the "auto" cleaning mode to start the cleaning that may be more appropriate for your home layout
No cleaning according to the preset time	<ul style="list-style-type: none"> - The power switch is not on - Scheduled appointment is cancelled 	<ul style="list-style-type: none"> - Turn on the power switch of appliance - Reset and make appointment
After the mop attachment is installed, the appliance is impermeable	<ul style="list-style-type: none"> - The mop holder magnet falls off - There's no water in water tank - The appliance base outlet hole is blocked 	<ul style="list-style-type: none"> - Contact the aftersales service center - Add water - Clear water outlet and tank filter
Appliance does not work	<ul style="list-style-type: none"> - The power switch is not turned on - Low battery - wheels are dropped and the three groups of drop sensors are in a falling state 	<ul style="list-style-type: none"> - Turn on the power switch - Charge the appliance - Place the appliance close to the ground - Contact aftersales service center
Appliance retreats	<ul style="list-style-type: none"> - There's obstacle ahead - Bumper rail is clamped 	<ul style="list-style-type: none"> - Clear the front obstacles - Tap the bumper rail to check for if there's foreign matter stuck
The appliance restart sometimes.	<ul style="list-style-type: none"> - This is a symptom caused by instantaneous discharge of static electricity caused by carpet. 	<ul style="list-style-type: none"> - The appliance will be normal if it restart within 3 seconds

TROUBLE SHOOTING

In case of mis-function, please refer to the following table.

Problem	Cause	Troubleshooting	Solution
App displays disconnection	Disconnection between the mobile phone and the equipment	<ul style="list-style-type: none"> - Judge if the mobile phone is accessed to network - Judge if the router works normally - The cleaner is required to be powered - The WiFi configurations of the equipment are cleared - The WiFi password or network is changed 	<ul style="list-style-type: none"> - The mobile phone shall be accessed to network once again - Re-start the router - Power on the cleaner once again - Add new appliances into App - After system start-up, long press "⏻" 3 seconds and release it after a tick sound is heard - Clear all WiFi configurations of the cleaner and add household electrical appliances once again for operation
Slow App operation	Network connection is not so smooth	<ul style="list-style-type: none"> - Network busy - Poor WiFi signal reception of the mobile phone - The network bandwidth is not so adequate 	<ul style="list-style-type: none"> - Re-start the router and reduce the number of access users - Check the settings of the mobile phone itself - Broaden network bandwidth

Open Source Announcement

The software included in this product contains open source software.

The following URL http://opensource.samsung.com/opensource/VR_5000_M/seq/O leads to open source license information as related to this product. This offer is valid to anyone in receipt of this information.

